

ESSIEUX COMPACT NON FREINÉS

750 kg

Technique

Modèle : COMPACT

Type essieu : 700 - 5

PTAC solo : 750 kg

Perçages : 100x4, 112x5, 130x4

Tourillon : 145 mm

Roulements : coniques

Fourniture comprenant

┆ Vis de roues

┆ Notice de montage et d'entretien

Protection de surface







┆ Corps d'essieu galvanisé



L'adaptation de la roue doit être vérifiée par le client ou par AL-KO SAS, dans ce cas, le client doit fournir un échantillon de roue à AL-KO SAS.

Attention : les dépports sont différents selon les perçages. Veuillez en tenir compte lors du choix de vos roues. À respecter également les gardes au coffre de roue (voir page 156).

Gamme

Voie mm	EAB mm	PERÇAGE EUROPÉEN 100 x 4				PERÇAGE EUROPÉEN 112 x 5				PERÇAGE SPÉCIAL 130 x 4			
		Corps standard		Avec liaison timon et brides hautes		Corps standard		Avec liaison timon et brides hautes		Corps standard		Avec liaison timon et brides hautes	
		Vis de roues coniques M 12x1,5		Vis de roues coniques M 12x1,5		Vis de roues sphériques M 12x1,5		Vis de roues sphériques M 12x1,5		Vis de roues sphériques M 14x1,5		Vis de roues sphériques M 14x1,5	
		Code article		Code article		Code article		Code article		Code article		Code article	
1130	700	200 392 01	25,0	200 392 22	27,0	200 393 01	25,0	200 393 22	27,0	200 533 01	25,0	200 533 23	27,0
1180	750	200 392 02	25,0	200 392 23	27,0	200 393 02	25,0	200 393 23	27,0	200 533 02	25,0	200 533 24	27,0
1230	800	200 392 03	25,0	200 392 24	27,0	200 393 03	25,0	200 393 24	27,0	200 533 03	25,0	200 533 25	27,0
1280	850	200 392 04	25,0	200 392 25	27,0	200 393 04	25,0	200 393 25	27,0	200 533 04	25,0	200 533 26	27,0
1330	900	200 392 05	26,0	200 392 26	28,0	200 393 05	26,0	200 393 26	28,0	200 533 05	26,0	200 533 27	28,0
1380	950	200 392 06	26,0	200 392 27	28,0	200 393 06	26,0	200 393 27	28,0	200 533 06	26,0	200 533 28	28,0
1430	1000	244 110	26,0	249 298	28,0	244 112	26,0	249 301	28,0	200 533 07	26,0	200 533 29	28,0
1480	1050	200 392 07	26,0	200 392 28	28,0	200 393 07	26,0	200 393 28	28,0	200 533 08	26,0	200 533 30	28,0
1530	1100	240 186	27,0	249 299	29,0	273 167	27,0	249 302	29,0	200 533 09	27,0	200 533 31	29,0
1580	1150	200 392 08	27,0	200 392 29	29,0	200 393 08	27,0	200 393 29	29,0	200 533 10	27,0	200 533 32	29,0
1630	1200	244 111	28,0	249 300	30,0	244 113	28,0	249 303	30,0	200 533 11	28,0	200 533 33	30,0
1680	1250	200 392 09	28,0	200 392 30	30,0	200 393 09	28,0	200 393 30	30,0	200 533 12	28,0	200 533 34	30,0
1730	1300	200 392 10	28,0	200 392 31	30,0	200 393 10	28,0	200 393 31	30,0	200 533 13	28,0	200 533 35	30,0
1780	1350	200 392 11	28,0	200 392 32	31,0	200 393 11	28,0	200 393 32	31,0	200 533 14	28,0	200 533 36	31,0
1830	1400	200 392 12	28,0	200 392 33	31,0	200 393 12	28,0	200 393 33	31,0	200 533 15	28,0	200 533 37	31,0
1880	1450	200 392 13	29,0	200 392 34	31,0	200 393 13	29,0	200 393 34	31,0	200 533 16	29,0	200 533 38	31,0
1930	1500	200 392 14	29,0	200 392 35	31,0	200 393 14	29,0	200 393 35	31,0	200 533 17	29,0	200 533 39	31,0
1980	1550	200 392 15	29,0	200 392 36	32,0	200 393 15	29,0	200 393 36	32,0	200 533 18	29,0	200 533 40	32,0
2030	1600	200 392 16	29,0	200 392 37	32,0	200 393 16	29,0	200 393 37	32,0	200 533 19	29,0	200 533 41	32,0
2080	1650	200 392 17	29,0	200 392 38	32,0	200 393 17	29,0	200 393 38	32,0	200 533 20	29,0	200 533 42	32,0
2130	1700	200 392 18	29,0	200 392 39	32,0	200 393 18	29,0	200 393 39	32,0	200 533 21	29,0	200 533 43	32,0
2180	1750	200 392 19	29,0	200 392 40	32,0	200 393 19	29,0	200 393 40	32,0	200 533 22	29,0	200 533 44	32,0

Liaison à boulonner pour corps $\square 60$
Code article 267 395

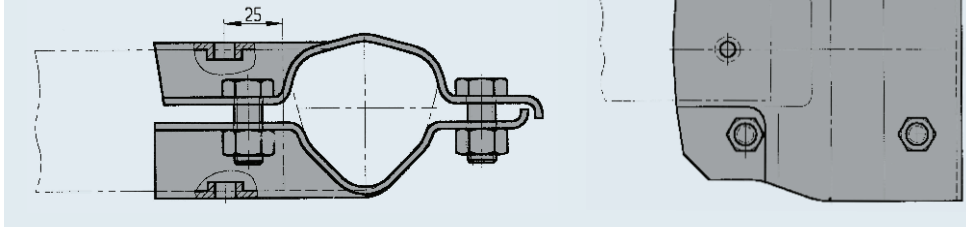

Corps standard

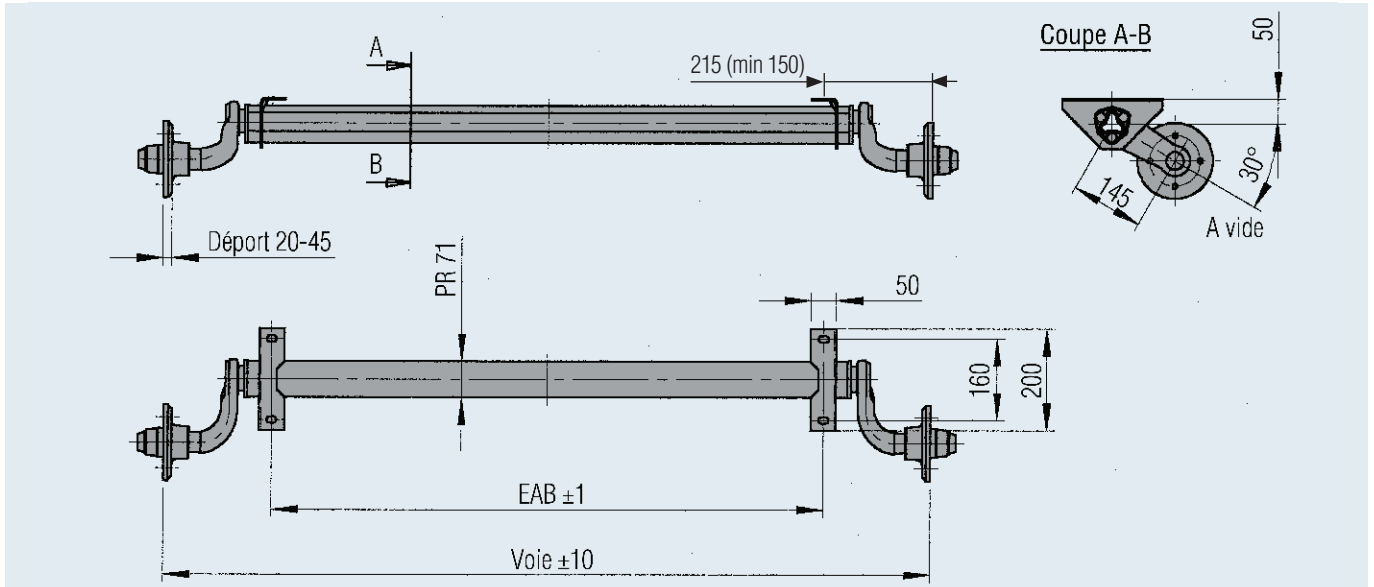

Avec liaison et brides hautes

